



Ultra-Miniature Automotive PCB Relay G8ND-2

- Compact Size
- High Performance PCB Relay
- Fully Automated Assembly
- Fully Sealed Construction
- SPDT Contacts with internal H-bridge



Available Types

Type	Description
G8ND-2	Standard Type
G8ND-2S	High Sensitivity (Low Pull-in Voltage)
G8ND-2U	Ultra-High Sensitivity
G8ND-27R	Reflow Solder Type (Vented, Higher Stand-off)
G8ND-27SR	Reflow Solder Type (Vented, Higher Stand-off) High Sensitivity
G8ND-27UR	Reflow Solder Type (Vented, Higher Stand-off) Ultra-High Sensitivity

Contact Data

Max. Switching Current	30 A
Max. Switching Voltage	16 V
Max. Carry Current	25 A (at 20°C for 1 hour)
Min. Carry Current	100 mA
Contact Material	Silver Tin Alloy – Cadmium Free

Coil Ratings (at 20°C)

Type	Rated Voltage	Coil Resistance	Nominal Power Consumption	Pull in Voltage	Dropout Voltage
G8ND-2	12VDC	225 Ω	640 mW	< 7.2 V	>1.0 V
G8ND-2S	12VDC	180 Ω	800 mW	< 6.5 V	>1.0 V
G8ND-2U	12VDC	130 Ω	1108 mW	< 5.5 V	>1.0 V
G8ND-27R	12VDC	225 Ω	640 mW	< 7.2 V	>1.0 V
G8ND-27SR	12VDC	180 Ω	800 mW	< 6.5 V	>1.0 V
G8ND-27UR	12VDC	130 Ω	1108 mW	< 5.5 V	>1.0 V

Typical Applications

Power Windows / Power Door Lock
Smart Junction Box and Module Applications
Seat Adjustment
Sunroof

Characteristics

Max. Initial Contact Voltage Drop / Resistance		50 mV / 50 mΩ (@ 1A, 12VDC)
Operate Time		100 ms max. (2.5 ms typical) @12V
Release Time		10 ms max. (1.2 ms typical)*
Bounce time	Operate	5 ms max. (0.5 ms typical)
	Release	10 ms max. (4.0 ms typical)
Switching Frequency	Mechanical	18,000 operations per hour
	Electrical	1,800 operations per hour (under rated loading)
Insulation Resistance		100 MΩ min. (@ 500 VDC)
Dielectric Strength		1.0 mA max leakage at 500 VAC, 50 – 60 Hz for 1 minute between coil and contacts and between contacts
Vibration	Mechanical durability	10 – 500 Hz, 45 m/s ²
	Malfuction durability	10 – 500 Hz, 45 m/s ²
Shock	Mechanical durability	1000 m/s ²
	Malfuction durability	100 m/s ² min.
Ambient Operating Temperature		-40°C to 85°C
Humidity		35% to 85% RH
Service life	Mechanical	1,000,000 operations min.
	Electrical	100,000 operations (load dependent)
Weight		7.5 g (approx.)

* External coil suppression will cause a measurable increase in release times and may cause the relay's characteristics to fall out of the specifications given here.

Characteristic Reference Data

Durability Test Data

Relay	Load Type	Current	Cycles Tested
G8N / G8NW / G8ND	Power window motor (locked)	26 A	200,000
	Door lock motor	27 A 8A Steady state	130,000

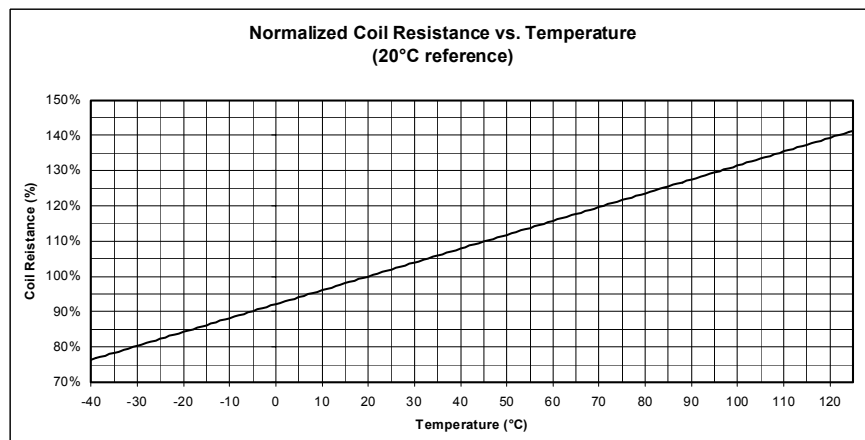

Example: Resistance of 225Ω coil
 = 75% of 225Ω at -40°C, or 169Ω
 = 100% of 225Ω at 20°C, or 225Ω
 = 125% of 225Ω at 85°C, or 281Ω

Characteristic Reference Data (Continued)

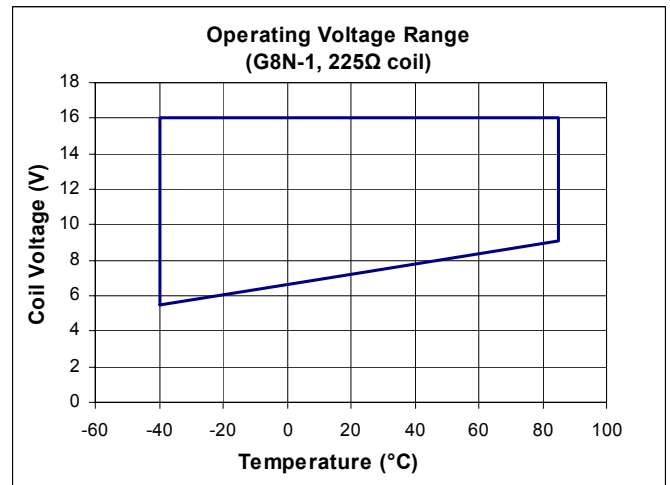
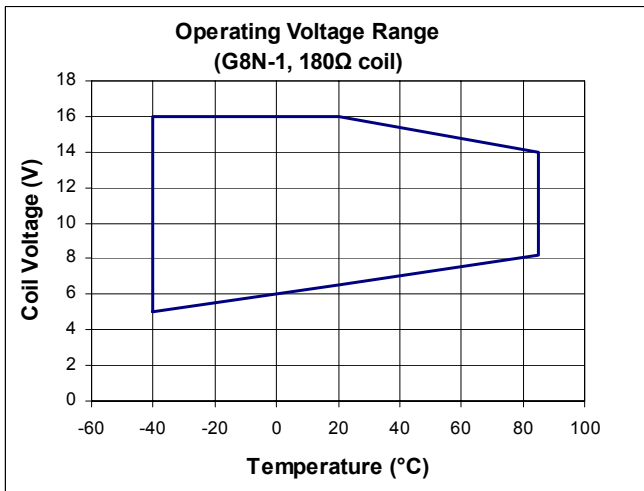
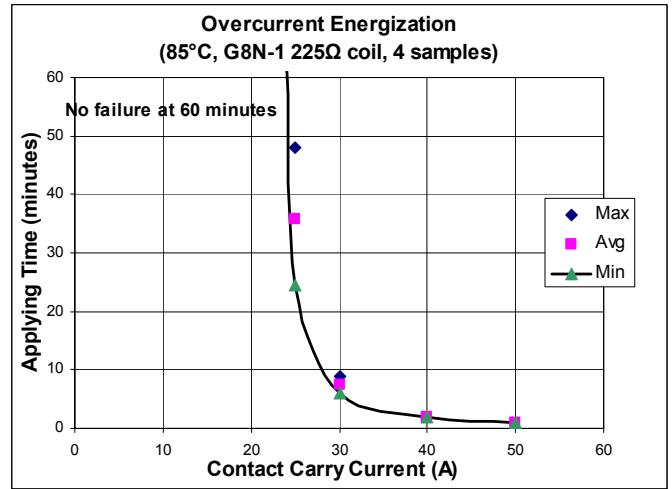
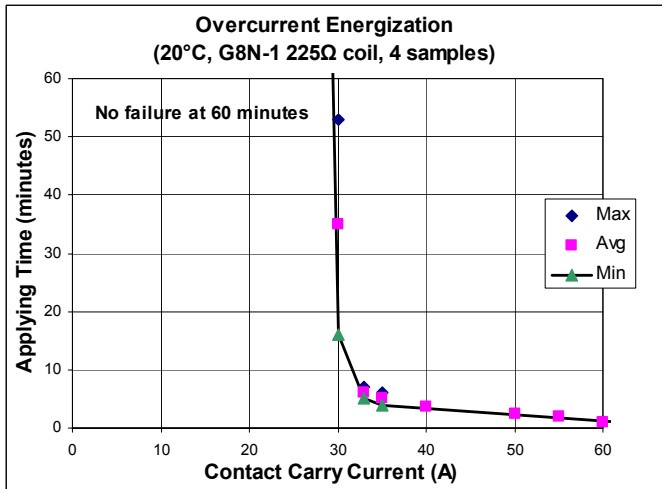
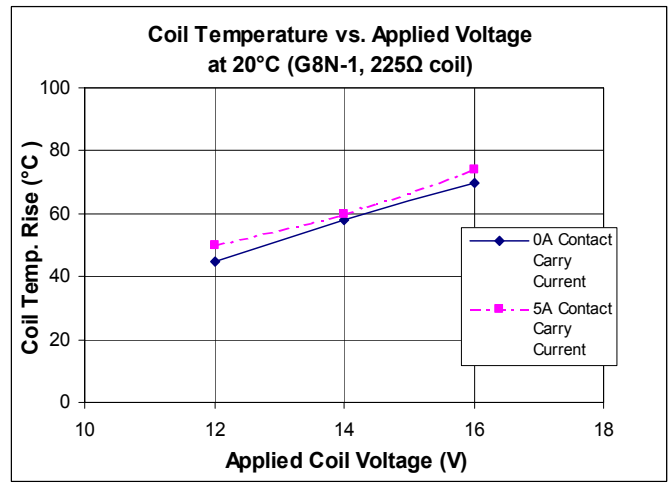
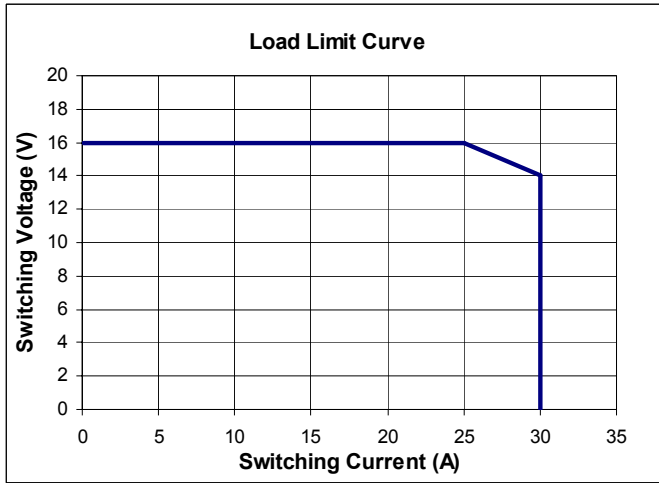

Dimensions

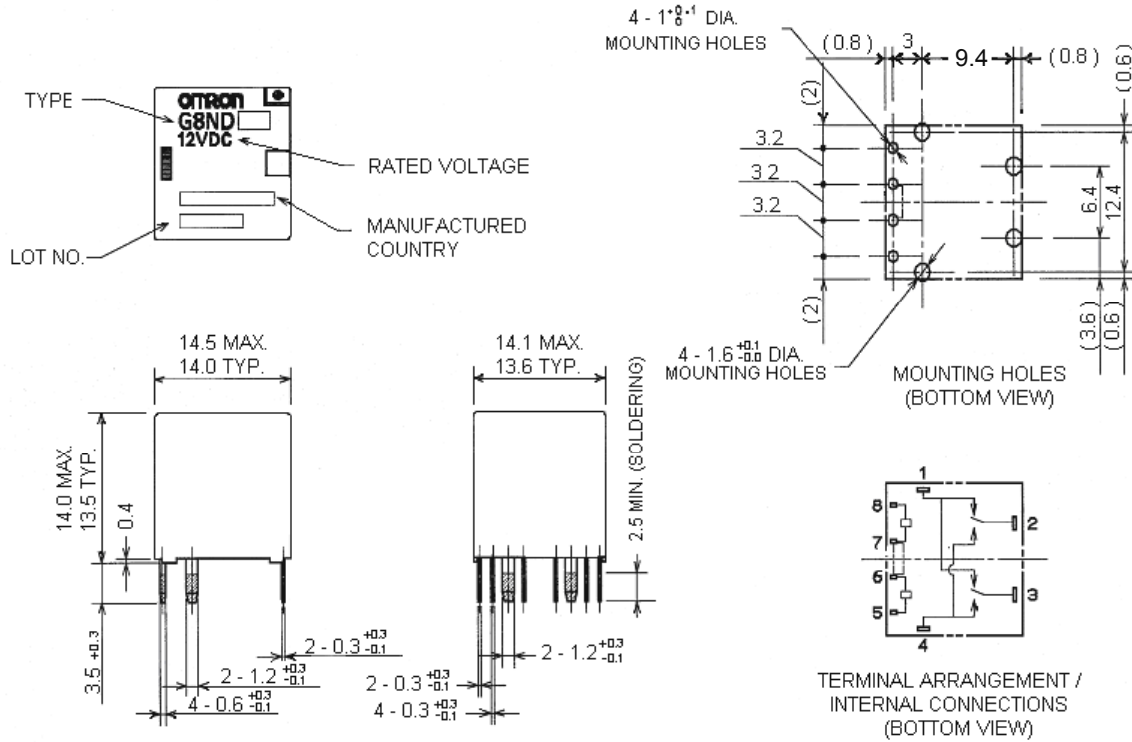

**Note: G8ND-27□R types have 0.7mm (not 0.4mm) standoffs for pin in paste process, to make the effective terminal length $3.2+0.3$ mm (not $3.5+0.3$ mm), and the height from the bottom of the standoffs to the top of the case 14.3mm MAX, 13.8mm TYP.

Tube Packaging

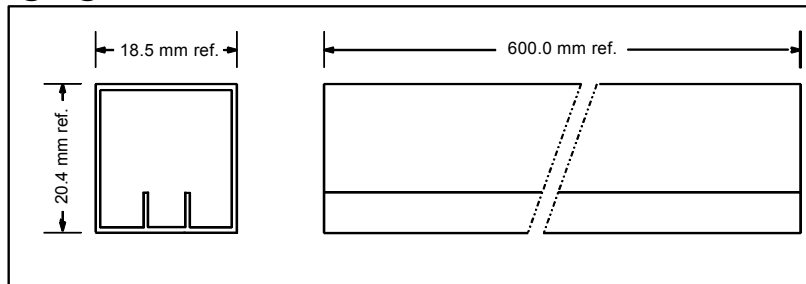

40 relays per tube, 30 tubes per box (1200 relays per box)

Notes:

1. For additional information, please contact Omron.
2. Prior to receipt of order, specifications subject to change without notice.
3. This specification sheet is intended to be a guideline for application of this product. The information contained is believed to be correct. However, it is impossible for Omron to evaluate every possible use. It is the user's responsibility to determine product suitability in any application.
4. Omron can meet some special performance characteristics upon request.
5. All data at 20°C unless otherwise noted.
6. If several relays are to be mounted on a single PCB, they must be given at least 3mm clearance on all sides