

INTELLIGENT POWER LOW SIDE SWITCH

Features

- Over temperature shutdown
- Over current shutdown
- Active clamp
- Low current & logic level input
- ESD protection
- Optimized Turn On/Off for EMI
- Diagnostic on the input current

Description

The IPS1031(S)(R)PbF is a three terminal Intelligent Power Switch (IPS) that features a low side MOSFET with over-current, over-temperature, ESD protection and drain to source active clamp. This device offers protections and the high reliability required in harsh environments. The switch provides efficient protection by turning OFF the power MOSFET when the temperature exceeds 165°C or when the drain current reaches 18A. The device restarts once the input is cycled. A serial resistance connected to the input provides the diagnostic. The avalanche capability is significantly enhanced by the active clamp and covers most inductive load demagnetizations.

Product Summary

Rds(on)	50mΩ (max.)
Vclamp	36V
Ishutdown	18A (typ.)

Packages

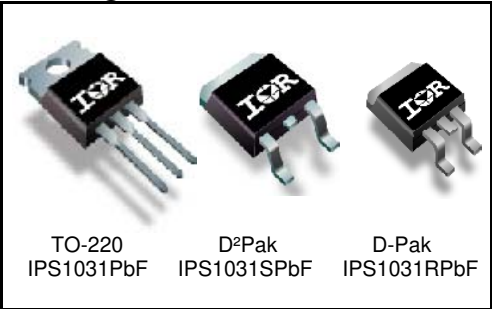

Typical Connection

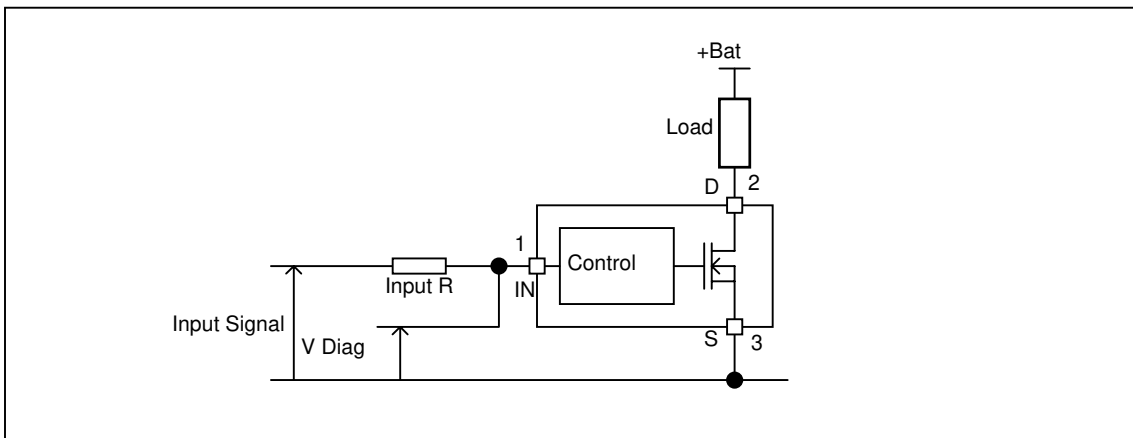

Absolute Maximum Ratings

Absolute maximum ratings indicate sustained limits beyond which damage to the device may occur. All voltage parameters are referenced to Ground lead. (Tambient=25°C unless otherwise specified).

Symbol	Parameter	Min.	Max.	Units
Vds	Maximum drain to source voltage	-0.3	36	V
Vds cont.	Maximum continuous drain to source voltage	-	28	V
Vin	Maximum input voltage	-0.3	6	V
I _{sd} cont.	Max. diode continuous current (limited by thermal dissipation)	—	4	A
Pd	Maximum power dissipation (internally limited by thermal protection)			
	R _{th} =5°C/W IPS1031	—	25	W
	R _{th} =40°C/W IPS1031S 1" sqr. footprint	—	3.1	
	R _{th} =50°C/W IPS1031R 1" sqr. footprint	—	2.5	
ESD	Electrostatic discharge voltage (Human body) C=100pF, R=1500Ω			
	Between drain and source	—	4	kV
	Other combinations	—	3	
	Electrostatic discharge voltage (Machine Model) C=200pF, R=0Ω			
Between drain and source	—	0.5		
	Other combinations	—	0.3	
T _j max.	Max. storage & operating temperature junction temperature	-40	150	°C
T _{soldering}	Lead soldering temperature (10 seconds)	—	300	°C

Thermal Characteristics

Symbol	Parameter	Typ.	Max.	Units
R _{th1}	Thermal resistance junction to ambient IPS1031 TO-220 free air	50	—	°C/W
R _{th2}	Thermal resistance junction to case IPS1031 TO-220	3.9	—	
R _{th1}	Thermal resistance junction to ambient IPS1031S D ² Pak std. footprint	60	—	
R _{th2}	Thermal resistance junction to ambient IPS1031S D ² Pak 1" sqr. footprint	40	—	
R _{th3}	Thermal resistance junction to case IPS1031S D ² Pak	3.9	—	
R _{th1}	Thermal resistance junction to ambient IPS1031R D-Pak std. footprint	70	—	
R _{th2}	Thermal resistance junction to ambient IPS1031R D-Pak 1" sqr. footprint	50	—	
R _{th3}	Thermal resistance junction to case IPS1031R D-Pak	3.9	—	

Recommended Operating Conditions

These values are given for a quick design. For operation outside these conditions, please consult the application notes.

Symbol	Parameter	Min.	Max.	Units
V _{IH}	High level input voltage	4.5	5.5	
V _{IL}	Low level input voltage	0	0.5	
I _{ds}	Continuous drain current, T _{ambient} =85°C, T _j =125°C, V _{in} =5V			A
	R _{th} =5°C/W IPS1031	—	9.5	
	R _{th} =40°C/W IPS1031S 1" sqr. footprint	—	3.3	
	R _{th} =50°C/W IPS1031R 1" sqr. footprint	—	3	
R _{in}	Recommended resistor in series with IN pin to generate a diagnostic	0.5	10	kΩ
Max L	Max recommended load inductance (including line inductance) (1)	—	50	μH
Max F	Max. frequency (switching losses = conduction losses)	—	1.5	kHz
Max. t _{rise}	Max. input rising time	—	1	μs

(1) Higher inductance is possible if maximum load current is limited - see figure 11

Static Electrical Characteristics

$T_j=25^{\circ}\text{C}$, $V_{cc}=14\text{V}$ (unless otherwise specified)

Symbol	Parameter	Min.	Typ.	Max.	Units	Test Conditions
Rds(on)	ON state resistance $T_j=25^{\circ}\text{C}$	—	40	50	m Ω	$V_{in}=5\text{V}$, $I_{ds}=8\text{A}$
	ON state resistance $T_j=150^{\circ}\text{C}$ (2)	—	76	95		
Idss1	Drain to source leakage current	—	0.1	10	μA	$V_{cc}=14\text{V}$, $T_j=25^{\circ}\text{C}$
Idss2	Drain to source leakage current	—	0.2	20		$V_{cc}=28\text{V}$, $T_j=25^{\circ}\text{C}$
V clamp1	Drain to source clamp voltage 1	36	39	—	V	$I_d=20\text{mA}$
V clamp2	Drain to source clamp voltage 2	—	40	42		$I_d=1\text{A}$
Vin clamp	IN to source pin clamp voltage	5.5	6.5	7.5		$I_{in}=1\text{mA}$
Vth	Input threshold voltage	—	1.7	—		$I_d=10\text{mA}$

Switching Electrical Characteristics

$V_{cc}=14\text{V}$, Resistive load= 1.5Ω , $R_{input}=0\Omega$, $V_{in}=5\text{V}$, $T_j=25^{\circ}\text{C}$

Symbol	Parameter	Min.	Typ.	Max.	Units	Test Conditions
Tdon	Turn-on delay time to 20%	3	10	30	μs	See figure 2
Tr	Rise time 20% to 80%	6	20	40		
Tdoff	Turn-off delay time to 80%	20	70	200		
Tf	Fall time 80% to 20%	6	15	30		
Eon + Eoff	Turn on and off energy	—	0.7	—	mJ	

Protection Characteristics

Symbol	Parameter	Min.	Typ.	Max.	Units	Test Conditions
Tsd	Over temperature threshold	150(2)	165	—	$^{\circ}\text{C}$	See figure 1
Isd	Over current threshold	12	18	24	A	See figure 1
OV	Over voltage protection (not active when the device is ON)	34	37	—	V	
Vreset	IN protection reset threshold	—	1.7	—	V	
Treset	Time to reset protection	15(2)	50	200	μs	$V_{in}=0\text{V}$

Diagnostic

Symbol	Parameter	Min.	Typ.	Max.	Units	Test Conditions
Iin, on	ON state IN positive current	15	32	70	μA	$V_{in}=5\text{V}$
Iin, off	OFF state IN positive current (after protection latched)	150	230	350		$V_{in}=5\text{V}$

(2) Guaranteed by design

Lead Assignments

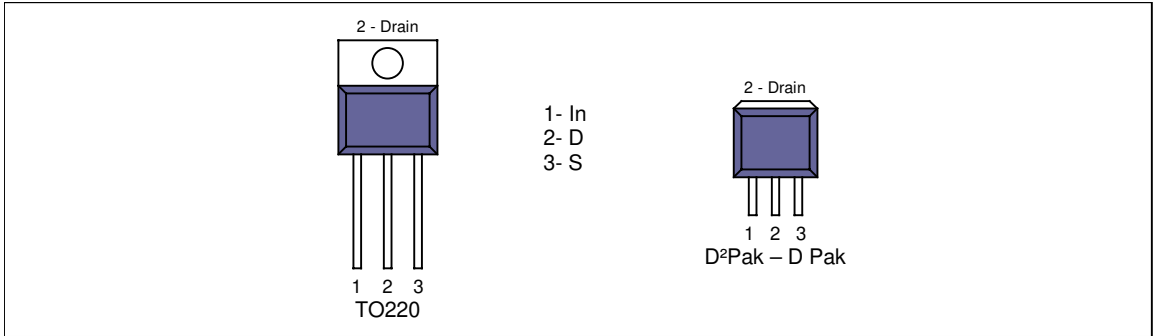

Functional Block Diagram

All values are typical

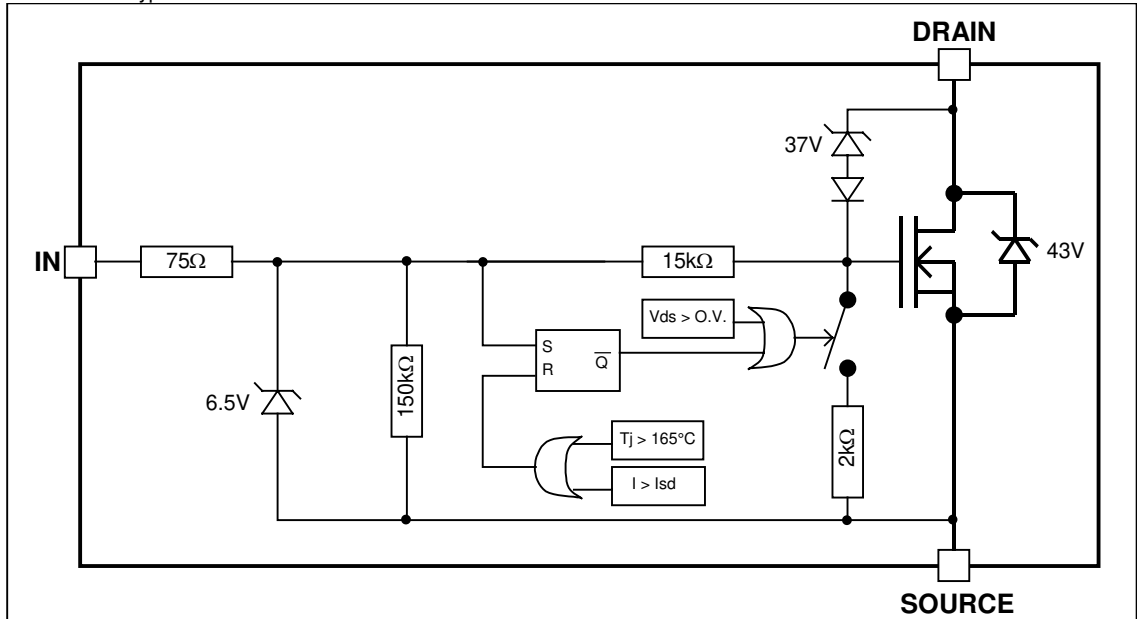

All curves are typical values. Operating in the shaded area is not recommended.

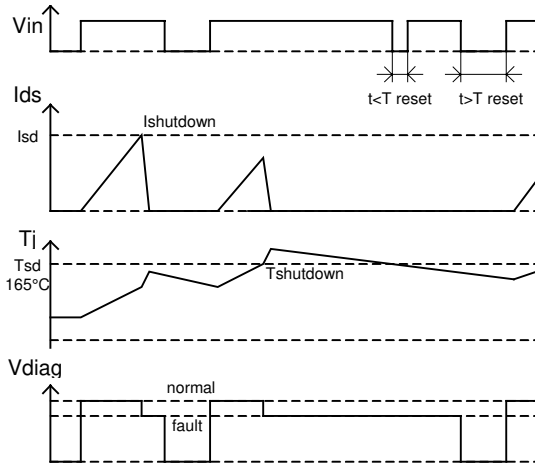

Figure 1 – Timing diagram

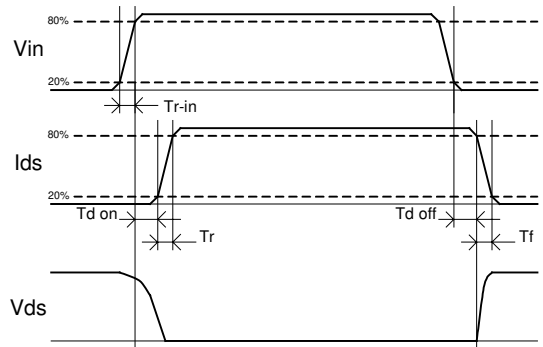

Figure 2 – IN rise time & switching definitions

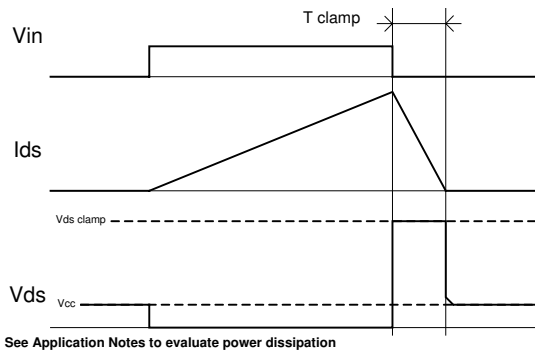

Figure 3 – Active clamp waveforms

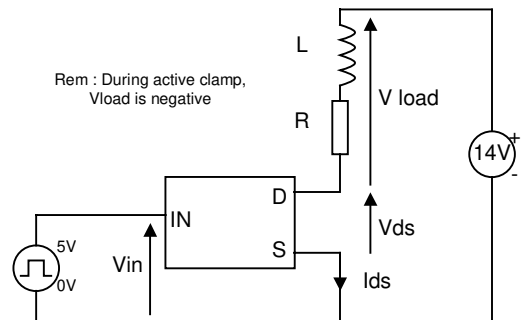

Figure 4 – Active clamp test circuit

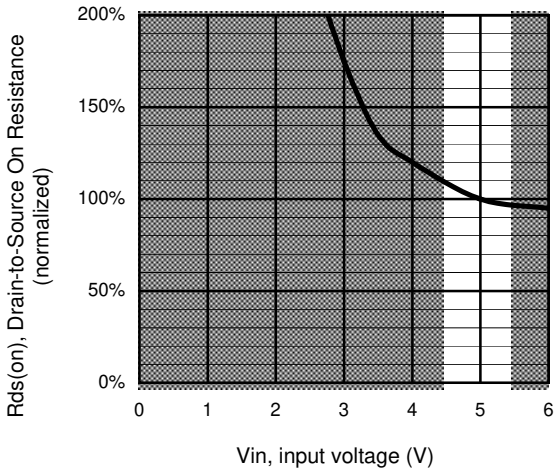

Figure 5 – Normalized Rds(on) (%) Vs Input voltage (V)

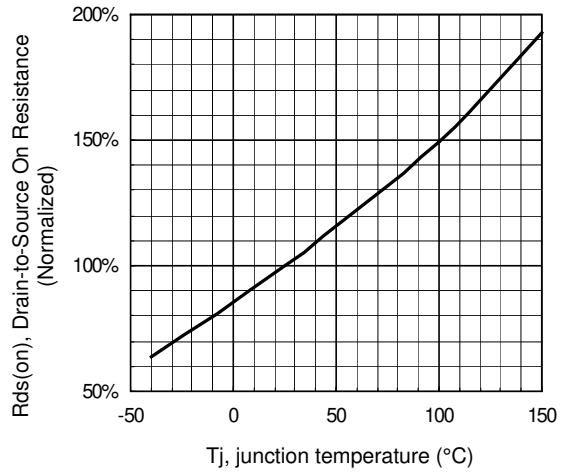

Figure 6 - Normalized Rds(on) (%) Vs Tj (°C)

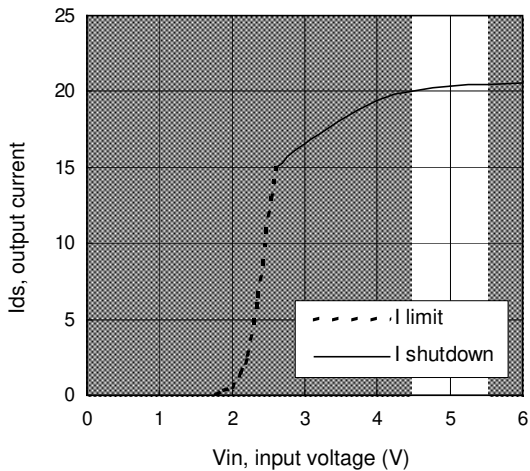

Figure 7 – Current limitation and current shutdown Vs Input voltage (V)

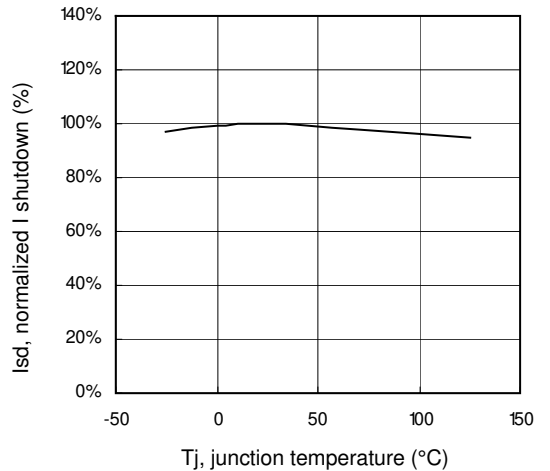

Figure 8 – Normalized I shutdown (%) Vs junction temperature (°C)

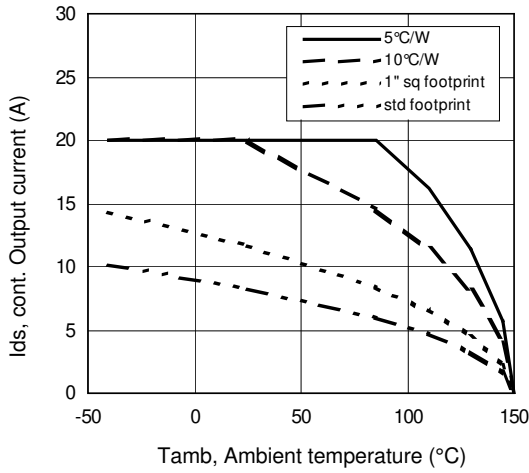

Figure 9 – Max. continuous output current (A) Vs Ambient temperature (°C)

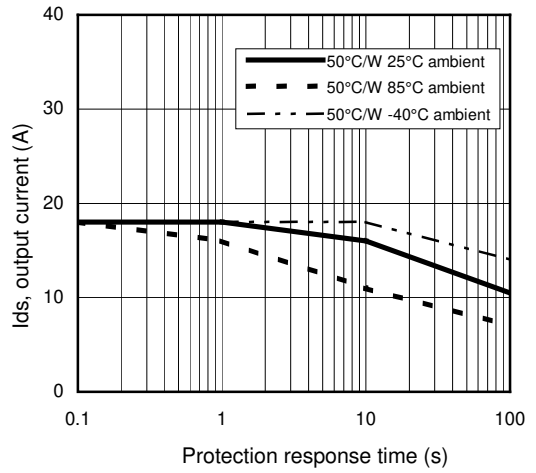

Figure 10 – I_{ds} (A) Vs over temperature protection response time (s)

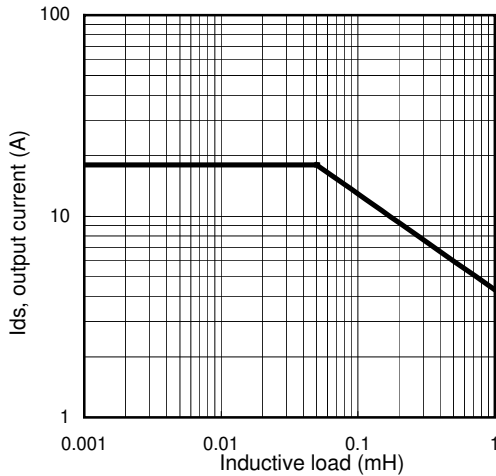

Figure 11 – Max. output current (A) Vs Inductive load (mH)

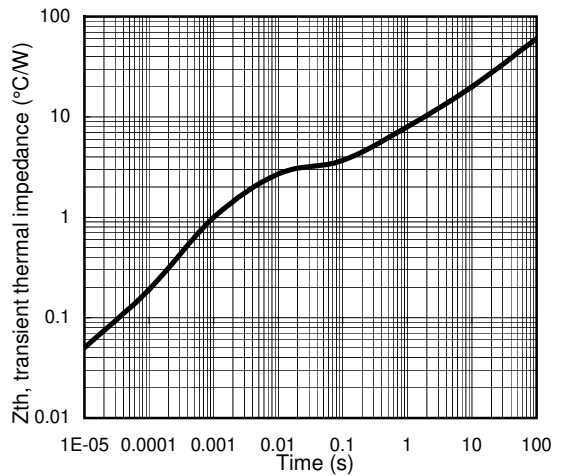

Figure 12 – Transient thermal impedance (°C/W) Vs time (s)

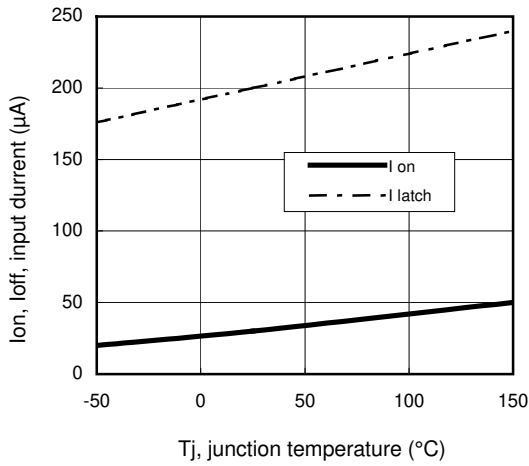

Figure 13 – Input current (µA) On and Off Vs junction temperature (°C)

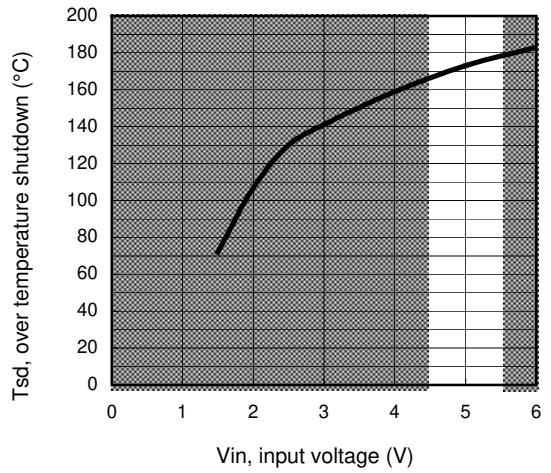
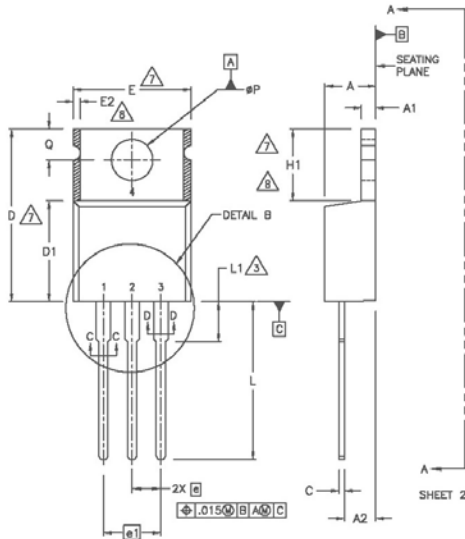
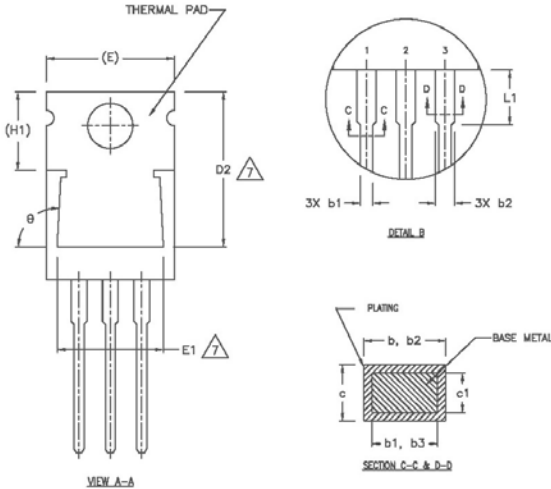

Figure 14 – Over temperature shutdown (°C) Vs input voltage (V)

Case Outline – TO-220 AB – Automotive Q100 PbF qualified



SYMBOL	DIMENSIONS				NOTES
	MILLIMETERS		INCHES		
	MIN.	MAX.	MIN.	MAX.	
A	3.56	4.82	.140	.190	
A1	0.51	1.40	.020	.055	
A2	2.04	2.92	.080	.115	
b	0.38	1.01	.015	.040	
b1	0.38	0.96	.015	.038	5
b2	1.15	1.77	.045	.070	
b3	1.15	1.73	.045	.068	
c	0.36	0.61	.014	.024	
c1	0.36	0.56	.014	.022	5
D	14.22	16.51	.560	.650	4
D1	8.38	9.02	.330	.355	
D2	12.19	12.88	.480	.507	7
E	9.66	10.66	.380	.420	4,7
E1	8.38	8.89	.330	.350	7
e	2.54 BSC		.100 BSC		
e1	5.08		.200 BSC		
H1	5.85	6.55	.230	.270	7,8
L	12.70	14.73	.500	.580	
L1	—	6.35	—	.250	3
φP	3.54	4.08	.139	.161	
Q	2.54	3.42	.100	.135	
φ	90°-93°		90°-93°		

NOTES:

- 1 DIMENSIONING AND TOLERANCING PER ASME Y14.5 M- 1994.
- 2 DIMENSIONS ARE SHOWN IN INCHES [MILLIMETERS].
- 3 LEAD DIMENSION AND FINISH UNCONTROLLED IN L1.
- 4 DIMENSION D & E DO NOT INCLUDE MOLD FLASH. MOLD FLASH SHALL NOT EXCEED .005" (0.127) PER SIDE. THESE DIMENSIONS ARE MEASURED AT THE OUTERMOST EXTREMES OF THE PLASTIC BODY.
- 5 DIMENSION b1 & c1 APPLY TO BASE METAL ONLY.
- 6 CONTROLLING DIMENSION : INCHES.
- 7 THERMAL PAD CONTOUR OPTIONAL WITHIN DIMENSIONS E,H1,D2 & E1
- 8 DIMENSION E2 X H1 DEFINE A ZONE WHERE STAMPING AND SINGULATION IRREGULARITIES ARE ALLOWED.
- 9 LEADS AND DRAIN ARE PLATED WITH 100% Sn

Case Outline - D²Pak (SMD-220) - Automotive Q100 PbF MSL1 qualified

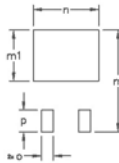
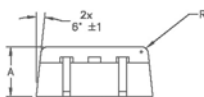
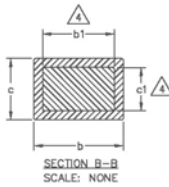
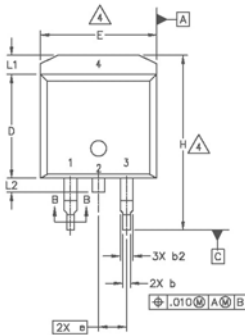
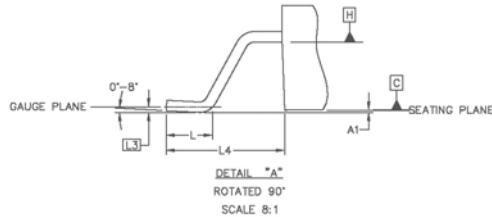
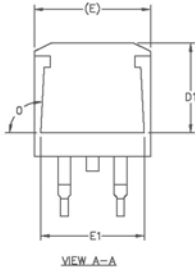

FOOT PRINT
SCALE 2:1

SYM BO L	DIMENSIONS				NOTES
	MILLIMETERS		INCHES		
	MIN.	MAX.	MIN.	MAX.	
A	4.06	4.83	.160	.190	
A1	0.00	0.254	.000	.010	
b	0.51	0.99	.020	.039	4
b1	0.51	0.89	.020	.035	
b2	1.14	1.78	.045	.070	
c	0.38	0.74	.015	.029	
c1	0.38	0.58	.015	.023	4
c2	1.14	1.65	.045	.065	
D	8.51	9.65	.335	.380	3
D1	8.86		.270		
E	9.65	10.67	.380	.420	3
E1	6.22		.245		
e	2.54 BSC		.100 BSC		
H	14.61	15.88	.575	.625	
L	1.78	2.79	.070	.110	
L1		1.65		.065	
L2	1.27	1.78	.050	.070	
L3	0.25 BSC		.010 BSC		
L4	4.78	5.28	.188	.208	
m	17.78		.700		
m1	8.89		.350		
n	11.43		.450		
o	2.08		.082		
p	3.81		.150		
R	0.51	0.71	.020	.028	
θ	90°	93°	90°	93°	

NOTES:

- DIMENSIONING AND TOLERANCING PER ASME Y14.5M-1994
- DIMENSIONS ARE SHOWN IN MILLIMETERS [INCHES]
- DIMENSION D & E DO NOT INCLUDE MOLD FLASH. MOLD FLASH SHALL NOT EXCEED 0.127 [0.005"] PER SIDE. THESE DIMENSIONS ARE MEASURED AT THE OUTMOST EXTREMES OF THE PLASTIC BODY.
- DIMENSION b1 AND c1 APPLY TO BASE METAL ONLY.
- CONTROLLING DIMENSION: INCH.
- LEADS & DRAIN CONTACT ARE PLATED : 100% Sn

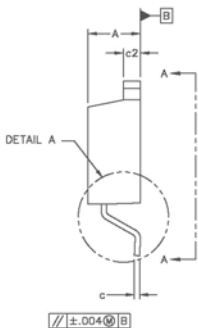

Tape & Reel - D²Pak (SMD220)

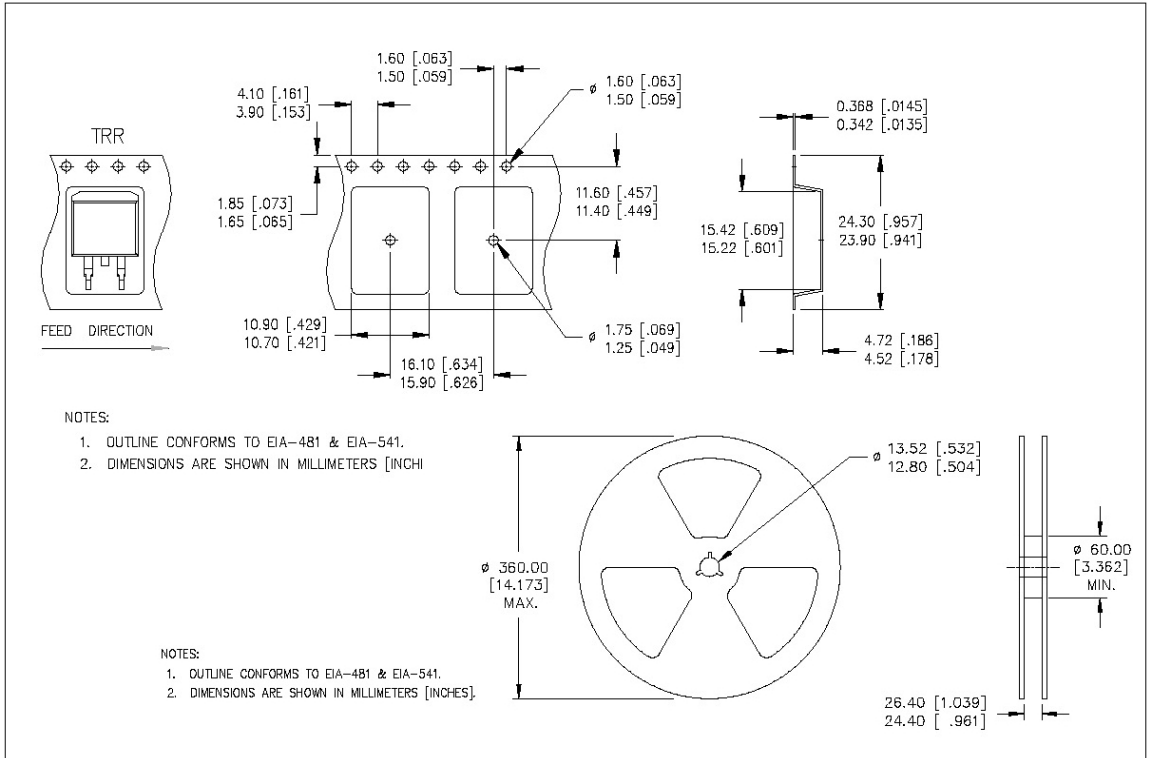

Case Outline – D-Pak - Automotive Q100 PbF MSL1 qualified

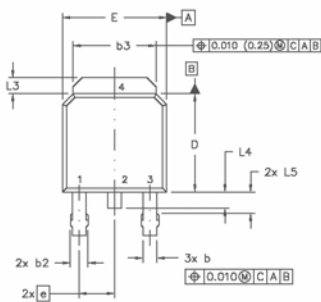
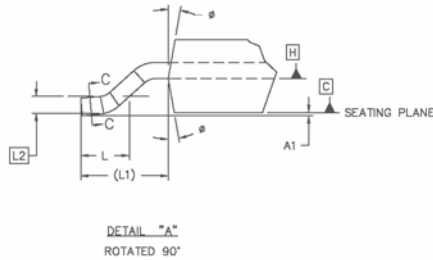
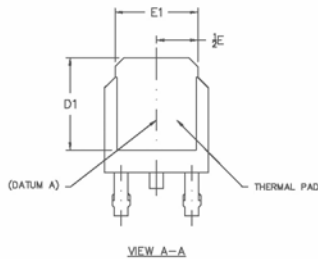

SYMBOL	DIMENSIONS		INCHES		NOTES
	MIN.	MAX.	MIN.	MAX.	
A	2.18	2.39	.086	.094	
A1		0.13		.005	
b	0.64	0.89	.025	.035	5
b1	0.64	0.79	.025	0.031	5
b2	0.76	1.14	.030	.045	
b3	4.95	5.46	.195	.215	
c	0.46	0.61	.018	.024	5
c1	0.41	0.56	.016	.022	5
c2	.046	0.89	.018	.035	5
D	5.97	6.22	.235	.245	6
D1	5.21	-	.205	-	4
E	6.35	6.73	.250	.265	6
E1	4.32	-	.170	-	4
e	2.29		.090 BSC		
H	8.40	10.41	.370	.410	
L	1.40	1.76	.055	.070	
L1	2.74 REF.		.108 REF.		
L2	0.051 BSC		.020 BSC		
L3	0.89	1.27	.035	.050	
L4		1.02		.040	
L5	1.14	1.52	.045	.060	3
ø	0"	10"	0"	10"	
ø1	0"	15"	0"	15"	

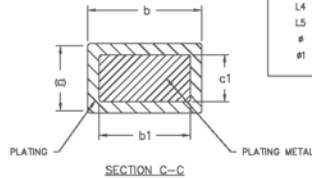
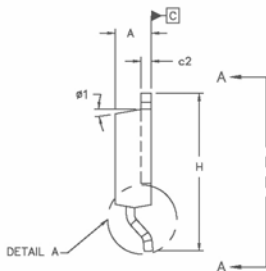

NOTES:

- 1.0 DIMENSIONING AND TOLERANCING PER ASME Y14.5 M- 1994.
- 2.0 DIMENSIONS ARE SHOWN IN INCHES [MILLIMETERS].
- 3.0 LEAD DIMENSION UNCONTROLLED IN L5
- 4.0 DIMENSION D1 AND E1 ESTABLISH A MINIMUM MOUNTING SURFACE FOR THERMAL PAD.
- 5.0 SECTION C-C DIMENSIONS APPLY TO THE FLAT SECTION OF THE LEAD BETWEEN .005 [0.127] AND .010 [0.2540] FROM THE LEAD TIP.
- 6.0 DIMENSION D & E DO NOT INCLUDE MOLD FLASH. MOLD FLASH SHALL NOT EXCEED .005" (0.127) PER SIDE. THESE DIMENSIONS ARE MEASURED AT THE OUTERMOST EXTREMES OF THE PLASTIC BODY.
- 7.0 OUTLINE CONFORMS TO JEDEC OUTLINE TO-252AA.
- 8.0 LEADS AND DRAIN ARE PLATED WITH 100% Sn

Tape & Reel - D-Pak

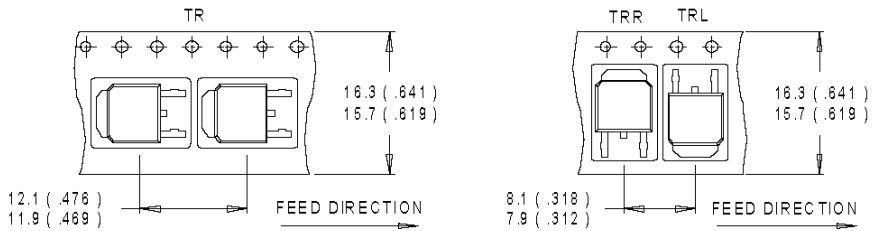

NOTES :

1. CONTROLLING DIMENSION : MILLIMETER.
2. ALL DIMENSIONS ARE SHOWN IN MILLIMETERS (INCHES).
3. OUTLINE CONFORMS TO EIA-481 & EIA-541.

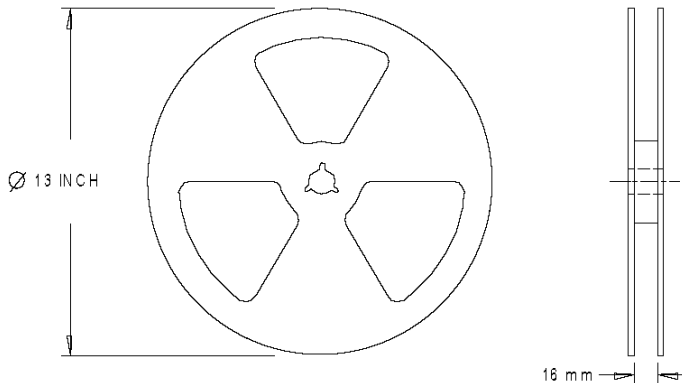

NOTES :

1. OUTLINE CONFORMS TO EIA-481.

Dimensions are shown in millimeters (inches)

Note: For the most current drawings please refer to the IR website at:
<http://www.irf.com/package/>